

OLED Light Panel

User Guide v1.0

Please read this user guide carefully before using the product.



Contents

Handling Instruction

A. Handling and Safety	2
B. Storage and Operation	3
C. Disposition	3

Installation

A. Product Overview	4
B. Preparing for use	5
- Connector - Molex	
- Power driver types	
- Additional Check Points	
C. Installation Guide	6
- Procedure: Driver Connection - Rigid / Flexible type panels	
- Connection Method - Schematic diagram	
- Driver list	

Technical Information

A. Product portfolio	11
B. Spectrum	15
C. Flux vs. Current	16
D. Lifetime	17
E. Efficacy vs. Luminance	17
F. CCT & Duv vs. Luminance	18
G. IV Curve	18
H. Voltage vs. Temperature.....	19
I. Uniformity & Surface Temperature.....	20
J. Angular Distribution	21
- Lambertian angle distribution	
- Δ UV angle distribution	

Reliability

A. Reliability test condition	22
- Rigid type	
- Flexible type	
- Operation lifetime	

※ Please note that the information given in this document is for your reference only, and is not to be misconstrued as guaranteed data. For the specifications of each product, please refer to the data sheet.

Handling Instruction

A. Handling and Safety

1. Unpack packing box with care. Remove packing trays gently and carefully from packing box.
2. During unloading and handling, gloves are required to prevent finger cuts or possible shocks.
Gloves are also required to avoid fingerprints being left on the glass, and to keep moisture from causing corrosion to the metal traces.
3. Handle panels with caution. Mechanical stress such as shocks and pressures on the panel surface (active area, encapsulation glass cavity area) must be avoided to prevent cracking of the glass, delamination, scratching of the film, and internal structure damage. Do not press or drop the panel.
4. During unloading and handling, panels should always be held from the side. Avoid direct contact with metal contact pads or connector traces.
5. Protect the panel surface from scratches. Avoid direct contact on panel surface and do not stack panels on top of each other.
6. Protect the corners and edges during handling, assembly or installation to prevent chipping or breakage of glass.
7. Avoid contact with chemicals such as solvents.
8. Contact with water must be avoided to prevent damage of films and corrosion of metal traces. Water drops must be wiped immediately.
9. To remove particle/foreign materials and surface stains, gently wipe the surface of the panel with non-abrasive cloth.
10. In case of breakage, avoid direct contact with bare hands. Do not swallow particles, chips, or materials.
11. For interconnections, spring contacts are recommended. Soldering and other interconnecting technologies which apply heat to the panel may cause damage, and are therefore not recommended.
12. Do not hold the panel on the surface. Hold the panel from the edge.
13. In case of connecting multiple panels, series connection is highly recommended. Panel to panel uniformity problem can occur by parallel connection.

Handling Instruction

B. Storage and Operation

1. Store and operate OLED panels within the ranges specified in the product specifications on page 11. Recommended temperature is at 25°C; Recommended relative humidity is below 70% (RH). (High temperature and humidity can cause film degradation, bubble generation, and film delamination)
2. Store panels in the trays and ESD pouches as delivered from LG Chem.

C. Disposition

1. Dispose OLED materials/panels/modules in accordance with each region's environmental laws and regulations. If necessary, consult qualified agencies on industrial waste treatment.

Installation

A. Product Overview

SA Model

Emitting side



Back side



SB Model

Emitting side



Back side

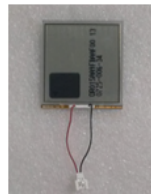

SC Model

Emitting side

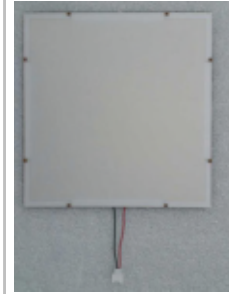

Back side



SD Model

Emitting side

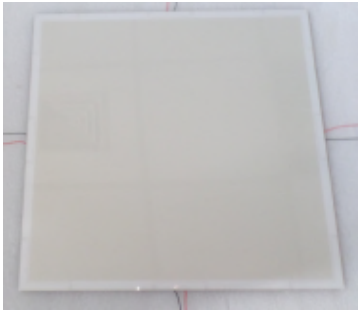

Back side

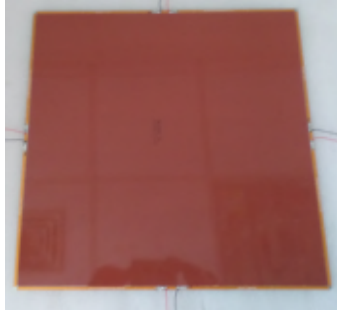

OA Model

Emitting side



Back side

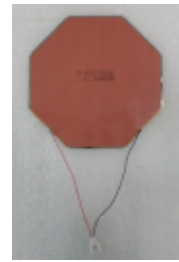

BA Model

Emitting side



Back side



PBA Model (Flexible)

Emitting side

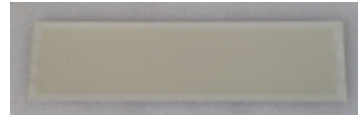

Back side



BB Model

Emitting side



Back side

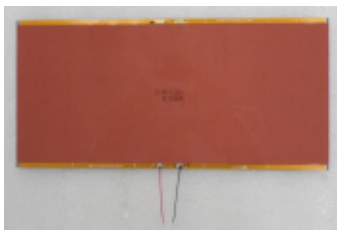

BC Model

Emitting side



Back side



Installation

B. Preparing for use

Connector - Molex

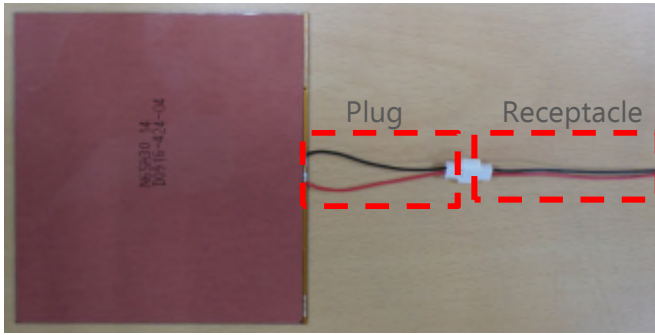

Fig. N6SA40-F (w/ molex connector)
* Maximum current per contact : 2A



Part #. 51006-0200
(Plug)



Part #. 51005-0200
(Receptacle)

Power Driver Types

Pulse width modulation (PWM)



Fig 1. PWM Driver (Recom)

Amplitude modulation (AM)



Fig 2. AM Driver (LG Innotek)

The two main driver types are AM and PWM.

When using AM drivers, select 'constant current' as output.

When using PWM drivers, select driver with current levels below 200% of panel's spec current.

* AM drivers produce a steady current, so they have less of an affect on OLED panel lifetime. PWM drivers deliver a 'peak' of current for each pulse, therefore, may have some affect on lifetime.

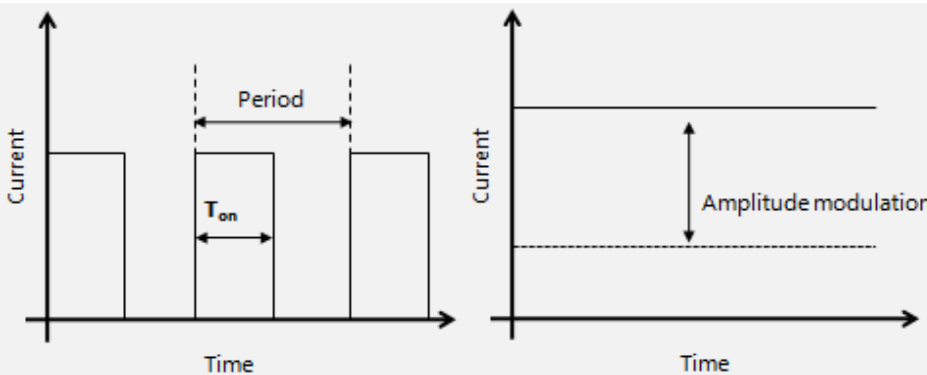

Additional Check Points

1. Connect panels in series. (Parallel connection may cause uneven brightness among panels)
2. Do not apply reverse bias. (Reverse bias may cause failure of the panels)

Installation

C. Installation guide: Driver Connection

Procedure - Rigid Type

※ This example is provided as a guideline to connecting OLED panels to drivers.
Please note that the Recom power driver may not be suitable for all panels or applications.

1. Compare Electric Levels

- See **page 9** for each **OLED** model's electric characteristics (ex. N6SA30)
- Check **Driver's** maximum output levels (ex. Recom)



		A. OLED	B. Driver
Model		N6SA30	Recom
(a)	Voltage [V]	8.5V	34VDC
(b)	Current [mA]	150mA	350mA

2. Select the Power Driver

Check Point (b) : Driver Current > OLED Current (ex. 350mA > 150mA)

→ If you wish to achieve brightness above spec levels, the Driver's Maximum Current must be higher than the OLED Specification Current. (Brightness is controlled by current input)

3. Determine the maximum number of OLED Panels per Driver

Check Point (a) : No. of panels x OLED Voltage < Driver Voltage

Ex) 8.5V x **3 panels** = 25.5V < 34VDC vs. 8.5V x *4 panels* = 34V ≥ 34VDC

→ Therefore, a Recom driver can drive up to three N6SA30 panels

4. Connect the OLED Panel (with Plug) to Receptacle (ex. N6SA30)

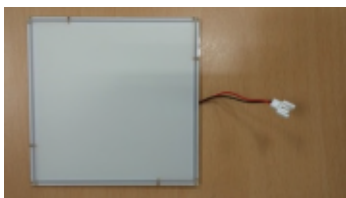

OLED panel with plug connector

+



Receptacle connector

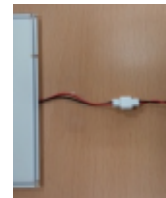

Plug and receptacle connected

5. Connect Receptacle to the Driver * See Schematic Diagram on page 7

1 panel

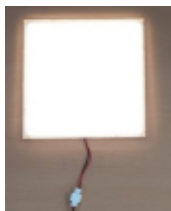

3 panels



→ To achieve exact brightness at spec levels, a dimmer must be used to control (reduce) the Driver's current levels

Installation

C. Installation guide: Driver Connection

Procedure – Flexible Type

※ This example is provided as a guideline to connecting OLED panels to drivers.
Please note that the Recom power driver may not be suitable for all panels or applications.

1. Compare Electric Levels

- A. See **page 9** for each **OLED** model's electric characteristics (ex. P6BA30)
- B. Check **Driver's** maximum output levels (ex. Recom)



		A. OLED	B. Driver
Model		P6BA30	Recom
(a)	Voltage [V]	8.6V	34VDC
(b)	Current [mA]	150mA	350mA

2. Select the Power Driver

Check Point (b) : Driver Current > OLED Current (ex. 350mA > 150mA)

→ If you wish to achieve brightness above spec levels, the Driver's Maximum Current must be higher than the OLED Specification Current. (Brightness is controlled by current input)

3. Determine the maximum number of OLED Panels per Driver

Check Point (a) : No. of panels x OLED Voltage < Driver Voltage

Ex) 8.6V x **3 panels** = 25.8V < 34VDC vs. 8.6V x **4 panels** = 34.4 V > 34VDC

→ Therefore, a Recom driver can drive up to three P6BA30 panels

4. Connect the Flexible OLED Panel to Driver

* See Schematic Diagram on page 8



Flexible OLED panel (with electrode pad)



1 panel



3 panels

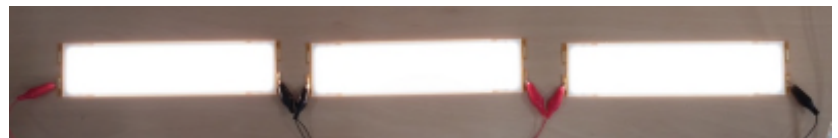

→ To achieve exact brightness at spec levels, a dimmer must be used to control (reduce) the Driver's current levels

Installation

C. Installation guide: Connection Method

Schematic Diagram - Rigid Type

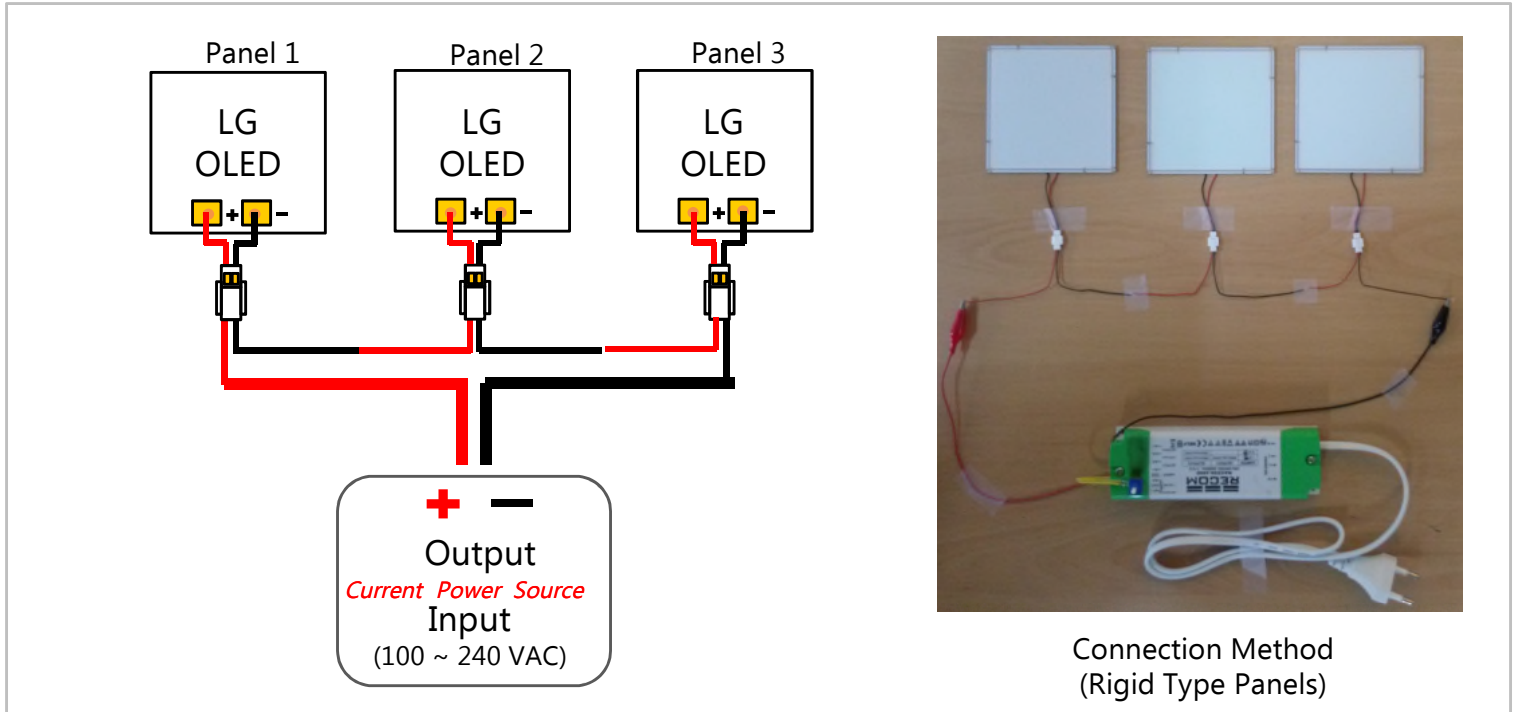

Schematic Diagram - Flexible Type

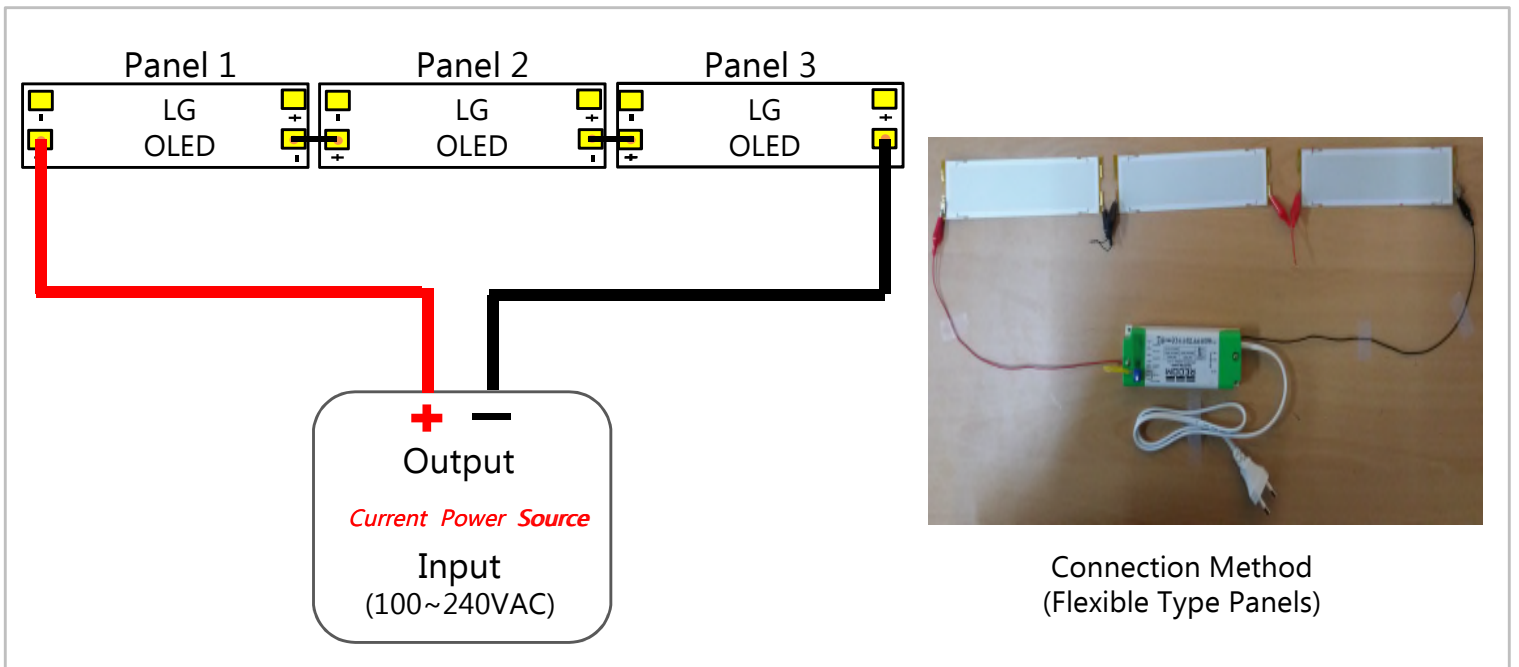

Installation

C. Installation guide

Electric Characteristics

Type		Rigid							
Model		N6SA40	N6SA30	N6SB40	N6SB30	N6SC40	N6SC30	N6BA40	N6BA30
Ⓐ	Voltage [V]	6.0	8.5	6.0	8.5	6.0	8.5	6.0	8.5
Ⓑ	Current [mA]	230	150	60	40	480	300	230	150
Ⓒ	Power [W]	1.38	1.28	0.36	0.34	2.88	2.55	1.38	1.28

Type		Rigid								Flexible	
Model		N6OA40	N6OA30	N6BB40	N6BB30	N6BC40	N6BC30	N6SD40	N6SD30	P6BA40	P6BA30
Ⓐ	Voltage [V]	6.0	8.5	6.0	8.5	6.0	8.5	6.0	8.5	6.0	8.6
Ⓑ	Current [mA]	230	150	800	500	570	370	2500	1600	230	150
Ⓒ	Power [W]	1.38	1.28	4.8	4.25	3.42	3.15	15	13.6	1.38	1.29

■ Recommended Power Supply

- Input : 100 ~ 240 VAC

- Max. Output : Voltage > Panel # x (Ⓐ), Current > (Ⓑ), Power > Panel # x (Ⓒ)

Installation

C. Installation guide

Driver list

■ Driver list-up (UL)

Product name	Company	Input		Output		Note
		Voltage	Frequency	Voltage	Current	
ALC12-36-R35	TDK*Lambda	Universal		3-36 V	0.35 A	12 W, No dimming
BPWXL 6-50U-012	BIAS	Universal		3-50 V	0.12 A	6W, No dimming
BPWXL 6-21U-035	BIAS	Universal		3-21 V	0.35 A	6W, No dimming
AC-5C500ABV	AceLEDs	Universal		6-10 V	0.5 A	5W, No dimming
L03E-350	MAGTECH	Universal		4-12 V	0.35 A	3W, No dimming
TC1 120 0350-6C	Fulham	120 VAC	50-60 Hz	3-18 V	0.35 A	6W No dimming

■ Driver list-up (CE)

Product name	Company	Input		Output		Note
		Voltage	Frequency	Voltage	Current	
ALC12-36-R35	TDK*Lambda	Universal		3-36 V	0.35 A	12 W, No dimming
LPLC-18-350	MeanWell	90 ~ 132 VAC	47~63 Hz	6-48 V	0.35 A	18 W, No dimming
L03E-350	MAGTECH	Universal		4-12 V	0.35 A	3W, No dimming
PCC35012	POWERLED	220-240 VAC	50~60 Hz	2-34 V	0.35 A	12W, No dimming
PCC50016	POWERLED	220-240 VAC	50~60 Hz	2-34 V	0.50 A	16W, No dimming
LPVC11A1C	HEP	220-240 VAC	50~60 Hz	3-30 V	0.35 A	10W, Dimming (O)
LPVC24H1C UNI	HEP	100-240 VAC	50~60 Hz	6-30 V	0.8 A	24W, Dimming (O)
LT20-28/700	FRIWO	230 VAC	50~60 Hz	5-27.5 V	0.7 A	10W Dimming (O)

Technical Information

A. Product Portfolio

Type	Rigid					
Shape						
Size (mm)	100 × 100		200 × 50		53 × 55	
Model	N6SA40	N6SA30	N6BA40	N6BA30	N6SB40	N6SB30
CCT (K)	4,000	3,000	4,000	3,000	4,000	3,000
Thickness* (mm)	0.88	0.88	0.88	0.88	0.88	0.88
Seal type	MFE Type**					
Efficacy (lm/W)	55	60	55	60	55	60
CRI (Ra)	90					
Flux (lm)	75	75	75	75	20	20
LT70 (hr)	30,000	40,000	30,000	40,000	30,000	40,000

* with OCF

**Metal Film Encapsulation

Technical Information

A. Product Portfolio

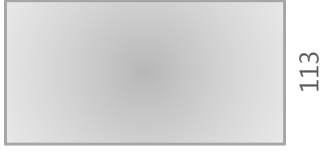
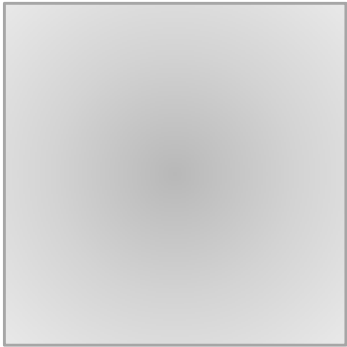

Type	Rigid			
Shape				
Size (mm)	213 × 113		320 × 320	
Model	N6BC40	N6BC30	N6SD40	N6SD30
CCT (K)	4,000	3,000	4,000	3,000
Thickness* (mm)	0.88	0.88	0.88	0.88
Seal type	MFE Type**			
Efficacy (lm/W)	55	60	55	60
CRI (Ra)	90			
Flux (lm)	185	185	800	800
LT70 (hr)	30,000	40,000	30,000	40,000

* with OCF

**Metal Film Encapsulation

Technical Information

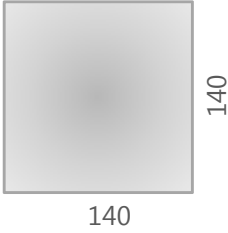
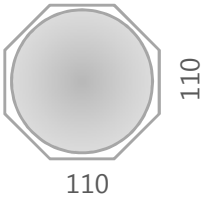
A. Product Portfolio

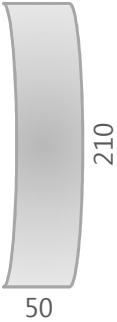
Type	Rigid						Flexible	
Shape								
Size (mm)	140 × 140		110 × 110		320 × 110		210 × 50	
Model	N6SC40	N6SC30	N6OA40	N6OA30	N6BB40	N6BB30	P6BA40	P6BA30
CCT (K)	4,000	3,000	4,000	3,000	4,000	3,000	4,000	3,000
Thickness (mm)*	0.88	0.88	0.88	0.88	0.88	0.88	0.25	0.25
Seal type	MFE Type**							
Efficacy (lm/W)	55	60	55	60	55	60	55	60
CRI (Ra)	90							
Flux (lm)	150	150	75	75	250	250	75	75
LT70 (hr)	30,000	40,000	30,000	40,000	30,000	40,000	30,000	40,000

* with OCF

**Metal Film Encapsulation

Technical Information

A. Product Portfolio

- The specification of each OLED panel is set at a standard brightness level of 3,000cd/m²
- Higher/lower light output can be achieved by controlling the current levels.
(Please note that there is a tradeoff between brightness levels and lifetime)

DC forward current & Luminous flux by Luminance

Model		Luminance (cd/m ²)	3,000	4,000	5,000
N6SA40, P6BA40, N6OA40,N6BA40	Current(mA)		230	307	383
	Flux(lm)		75	100	125
N6SA30, P6BA30, N6OA30, N6BA30	Current(mA)		150	200	250
	Flux(lm)		75	100	125
N6SB40	Current(mA)		60	80	100
	Flux(lm)		20	27	33
N6SB30	Current(mA)		40	53	67
	Flux(lm)		20	27	33
N6SC40	Current(mA)		480	640	800
	Flux(lm)		150	200	250
N6SC30	Current(mA)		300	400	500
	Flux(lm)		150	200	250
N6BB40	Current(mA)		800	1067	1333
	Flux(lm)		250	333	417
N6BB30	Current(mA)		500	667	833
	Flux(lm)		250	333	417
N6BC40	Current(mA)		570	760	950
	Flux(lm)		185	247	308
N6BC30	Current(mA)		370	493	617
	Flux(lm)		185	247	308
N6SD40	Current(mA)		2500	3333	4167
	Flux(lm)		800	1067	1333
N6SD30	Current(mA)		1600	2133	2667
	Flux(lm)		800	1067	1333

Technical Information

B. Spectrum

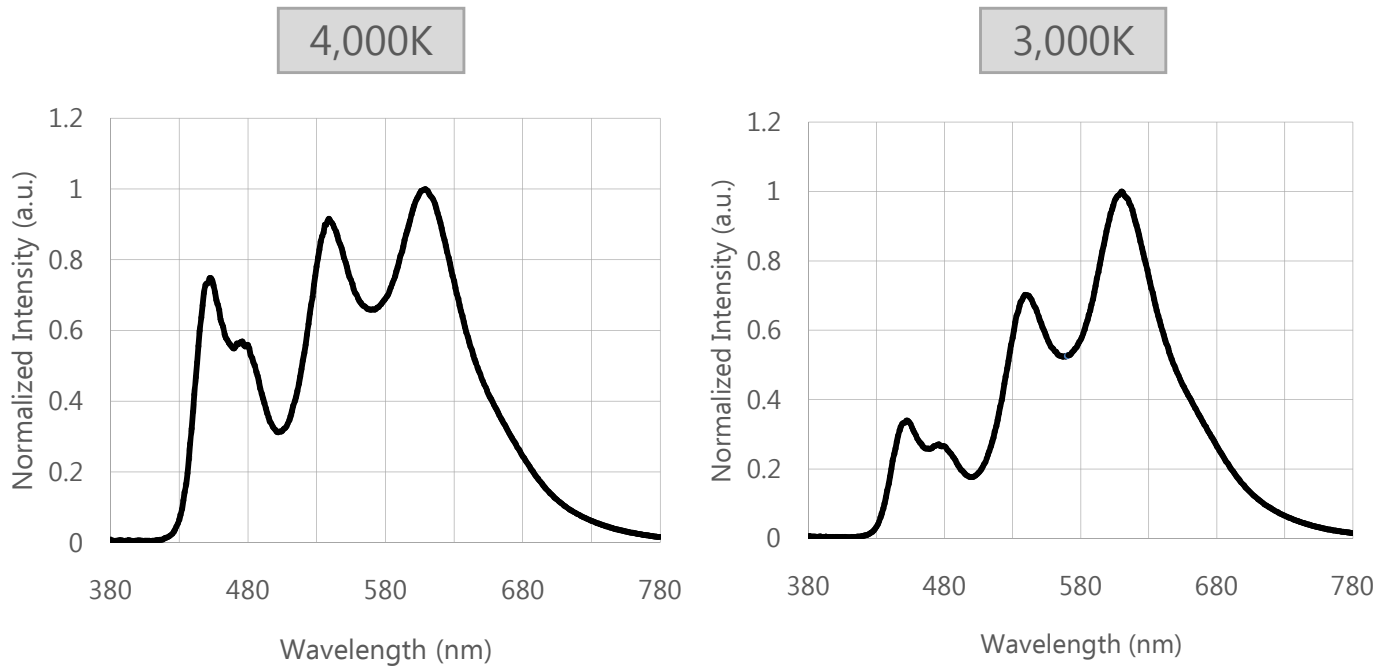

- LG Chem OLED Panels are available in colour temperatures of 4,000K (cool white) and 3,000K (warm white).
- LG Chem OLED panels have high Colour Rendering properties (CRI above 90).
- Natural and Human-Friendly Light Quality
 - LG Chem OLEDs have spectral distributions that are closest to those of natural light.
 - LG Chem OLEDs produce pleasant and comfortable light with no heat or glare issues.

Technical Information

C. Flux vs Current

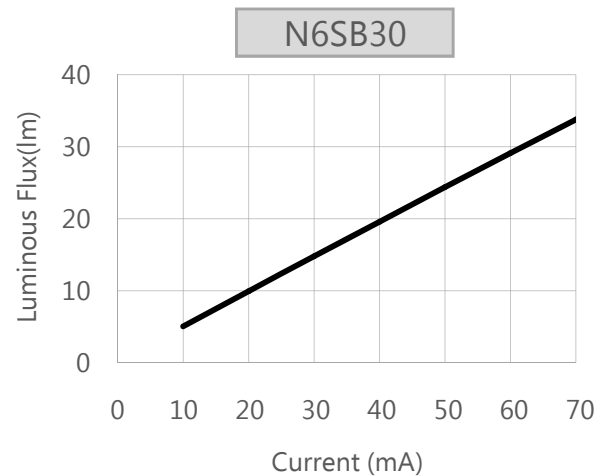
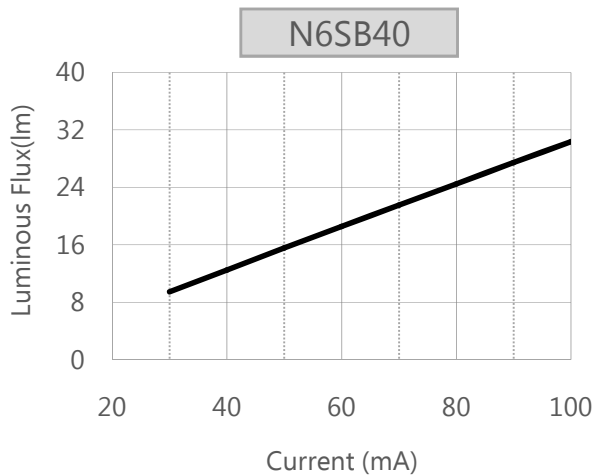
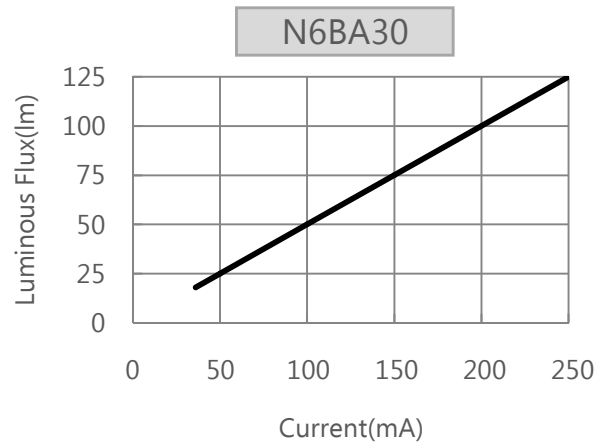
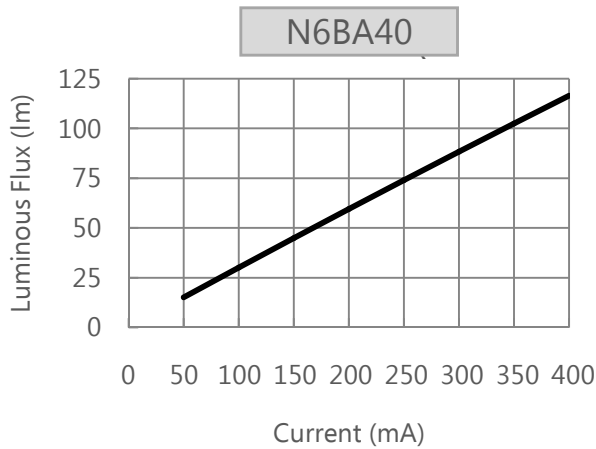
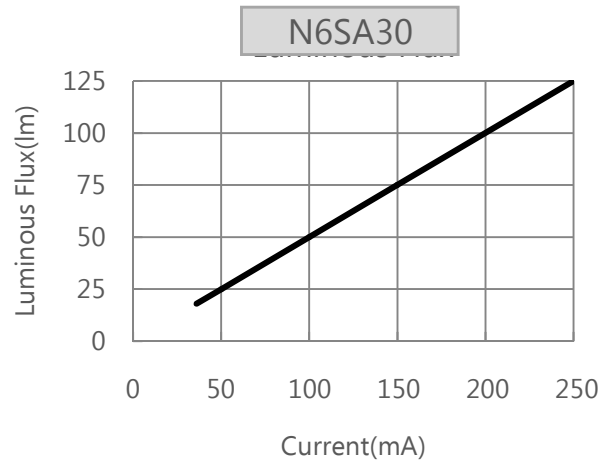
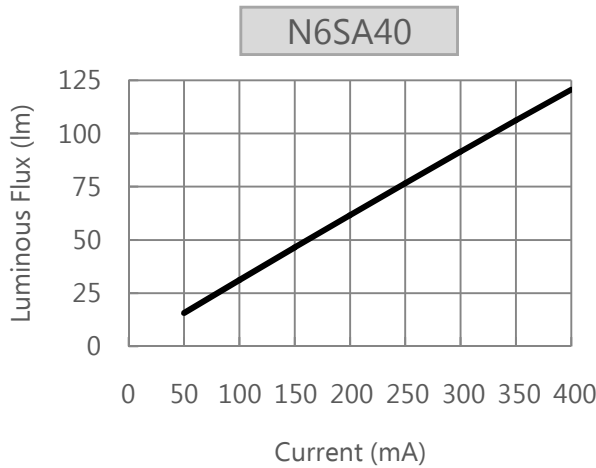

- Flux(lm) is proportional to current.
- Refer to dc forward current (page 14).

Technical Information

D. Lifetime

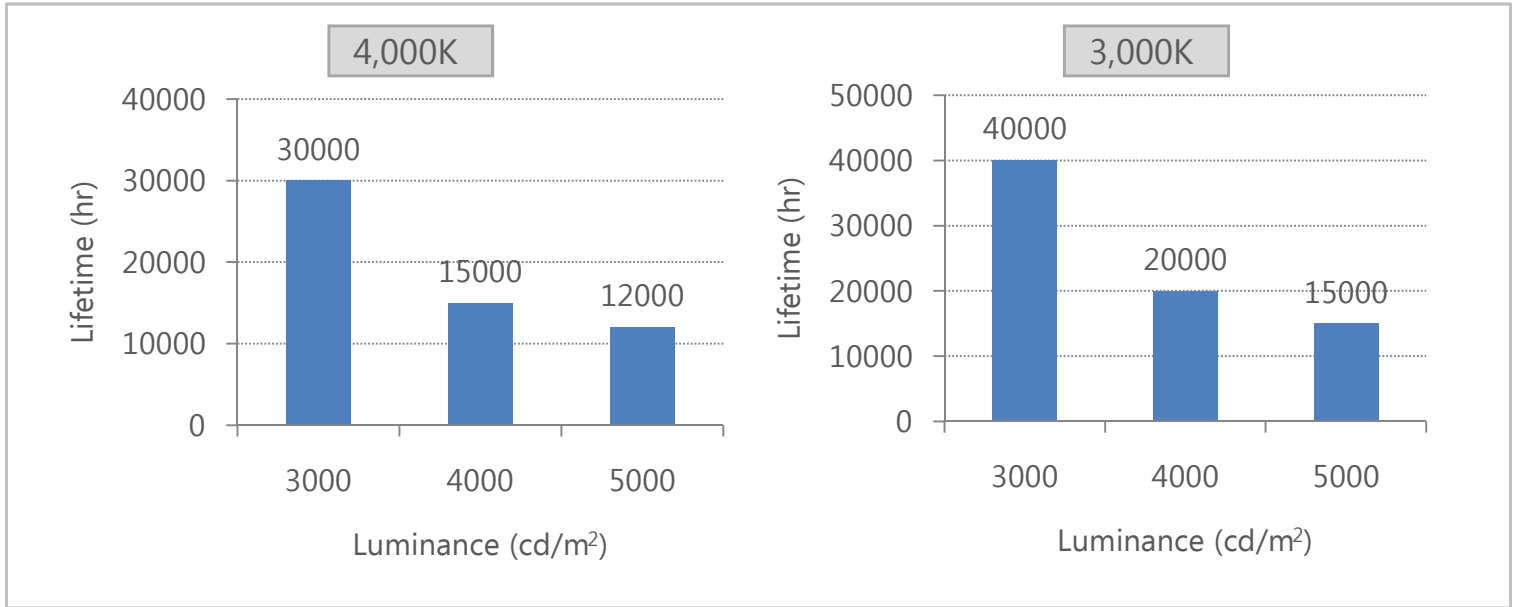

E. Efficacy vs. Luminance

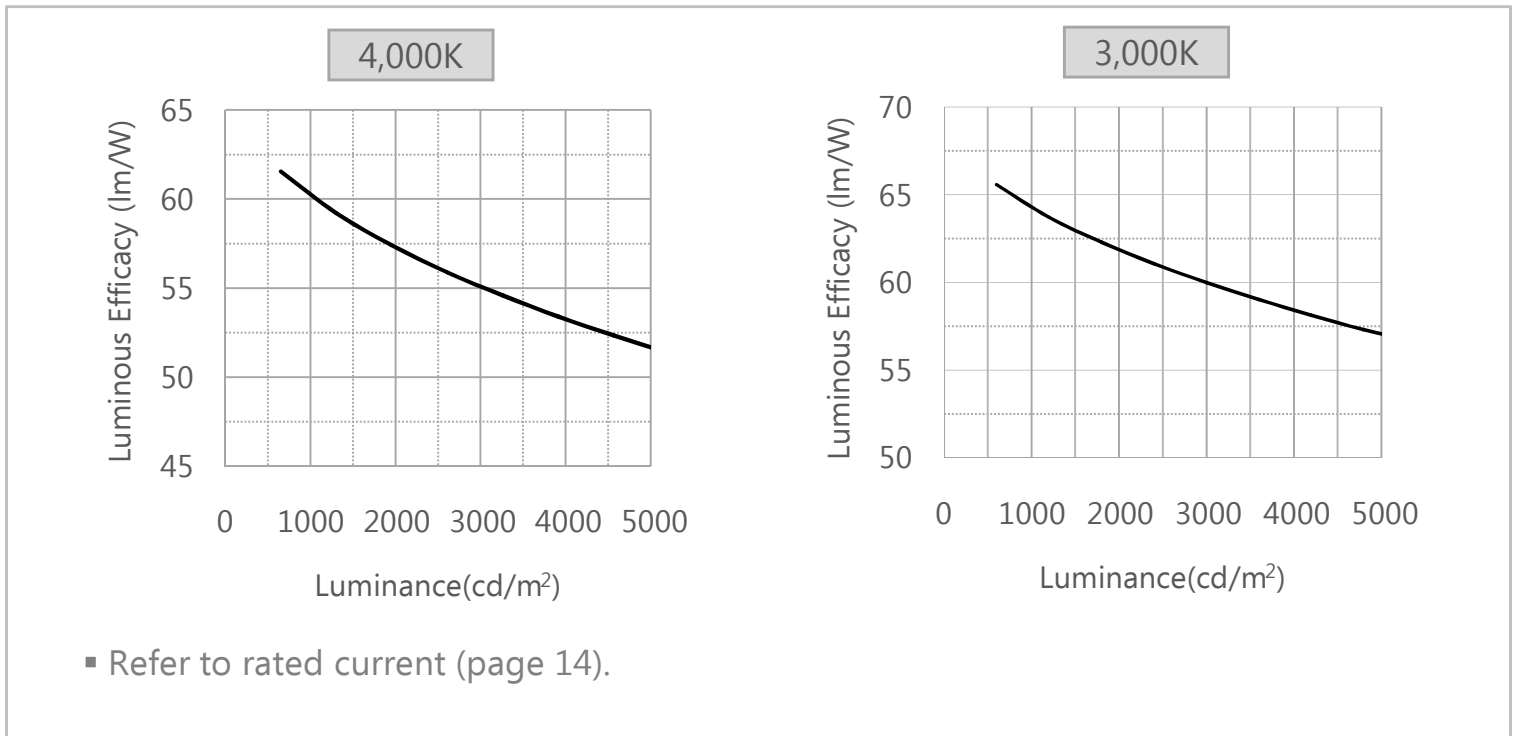

Technical Information

F. CCT & Duv vs. Luminance

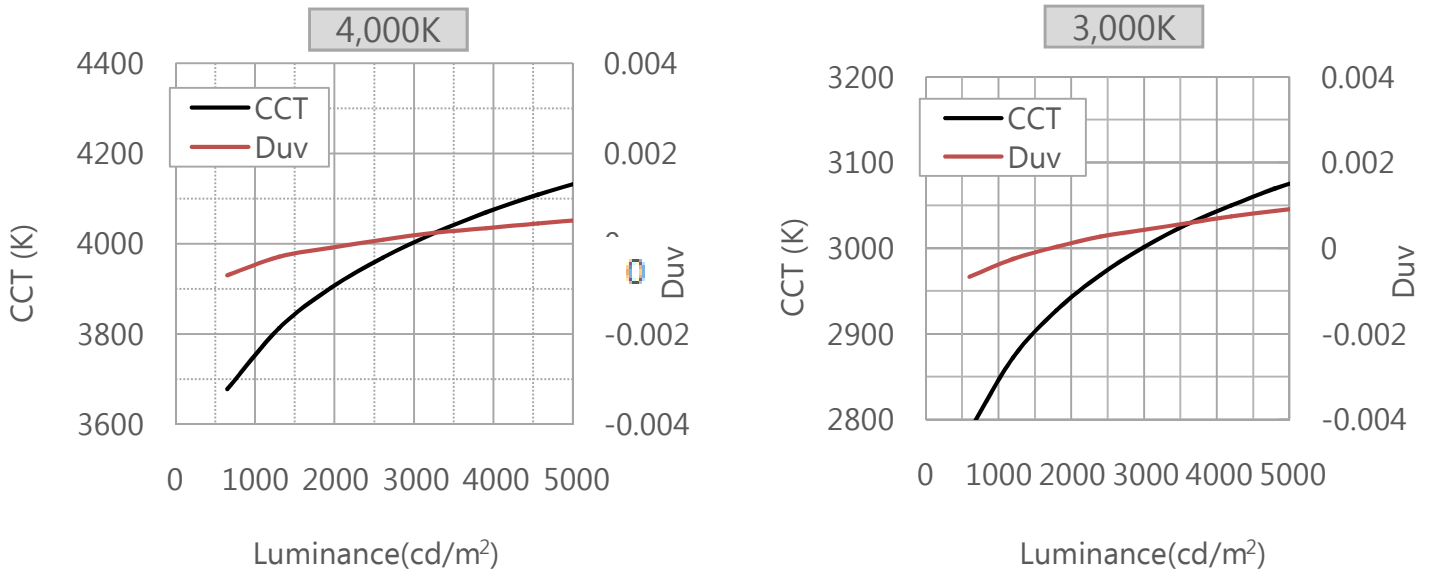

▪ Refer to dc forward current (page 14).

G. IV Curve

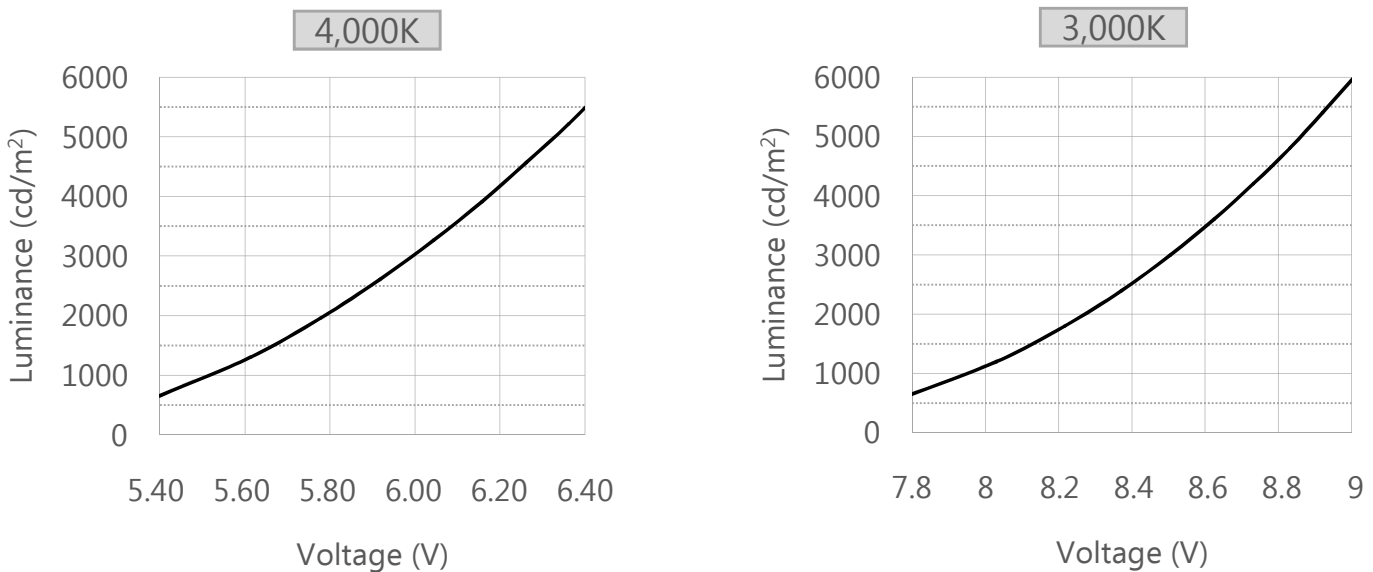

▪ Refer to dc forward current (page 14).

Technical Information

H. Voltage vs. Temperature

Voltage vs. Temperature

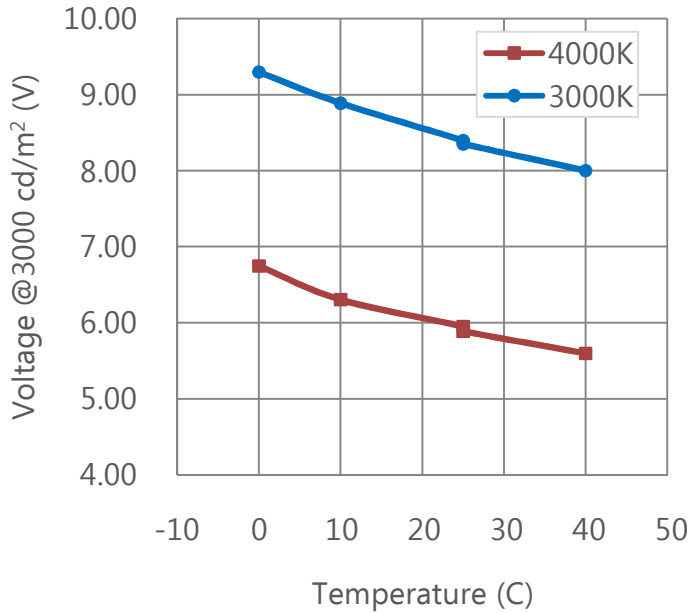

- Voltage is inversely proportional to atmosphere temperature.
- Recommended operating temperature is 0°C ~40°C

Technical Information

I. Uniformity & Surface Temperature

Measurement of Uniformity

- Measuring Equipment
 - CA-2000, Konica Minolta
- Method
 - Optical camera measures the luminance of each pixel at a right angle to the panel.
 - It generally takes about 5 minutes to reach peak uniformity.
 - The number of pixels depends on the size of active area; typically 1 pixel = 100mm²
 - Luminous uniformity calculation formula

$$U = [1 - (L_{max} - L_{min}) / (L_{max} + L_{min})] \times 100\%$$

Surface Temperature / Time

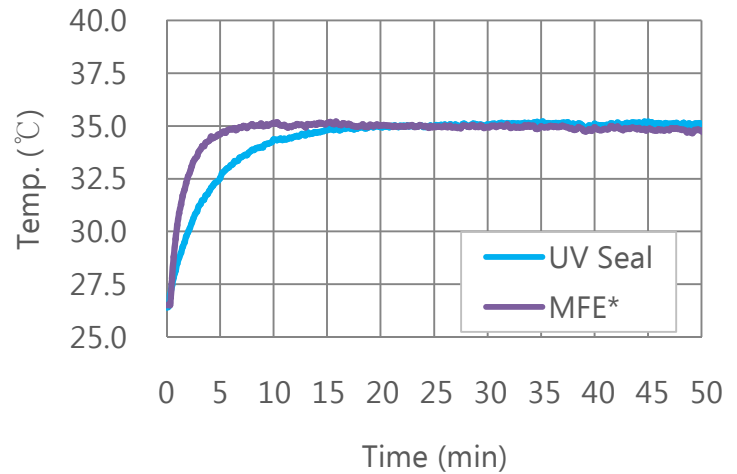

- Measuring Equipment
 - Thermal burn camera, FLIR
- Time to reach maximum surface temperatures (34°C ~35°C @3,000cd/m²)
 - MFE* type panels: 5 minutes
 - UV seal type panels: 15 minutes

Surface Temperature / Brightness

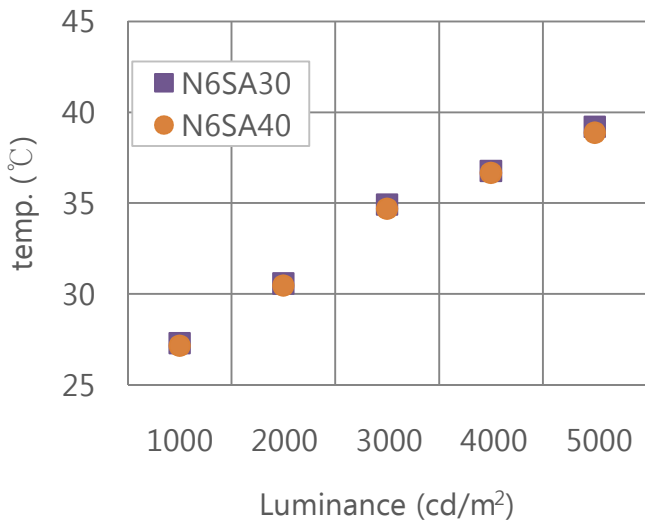

- Surface temperature increases along with brightness levels
- The increase ratio is similar for all models.

* Metal Film Encapsulation

Technical Information

J. Angular Distribution

Lambertian Angle distribution

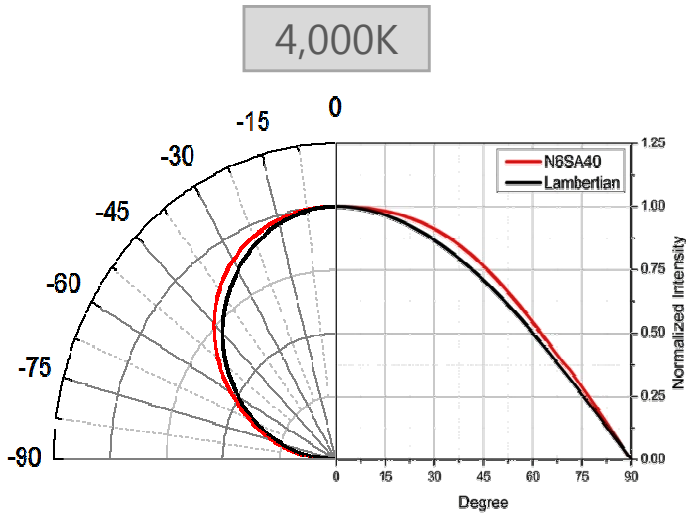

- Angle distribution for 4000K models is similar to the Lambertian curve, with the ratio at approximately 1.05.

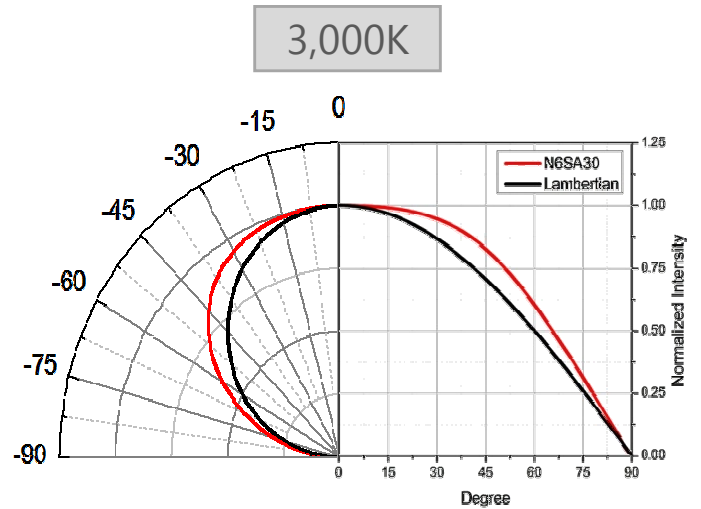

- Angle distribution for 3000K models is shaped in an ellipse with the ratio at approx. 1.12
- $\text{Nit}(\text{cd}/\text{m}^2) \times \text{Active area} \times \pi \times \text{Lambertian Ratio} = \text{Flux (lm)}$

Δuv Angle distribution

Δuv (color change) by angle

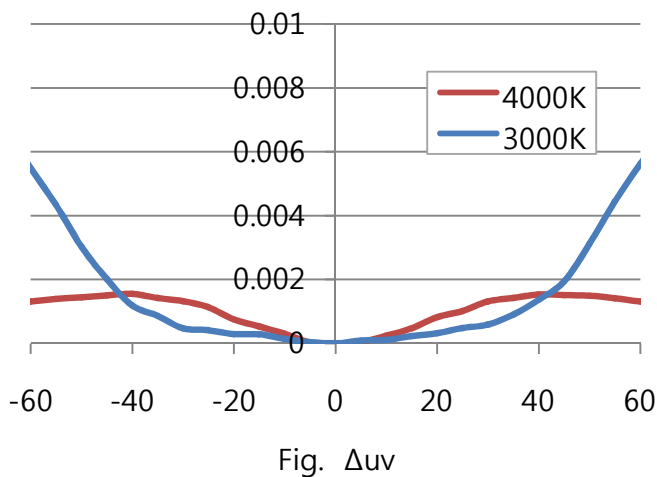

- Measuring Equipment
 - Goniometer
- Method
 - The panel is rotated from -90° to $+90^\circ$ and is measured at each 5° .
- Generally, Δuv is estimated by the data at 60° .

Reliability

A. Reliability test condition

Rigid type

- Evaluation criteria : Luminance change within $\pm 10\%$ of initial value

Items	Condition
High temperature/humidity operation	60°C, 90% RH / IF=Typ.mA,96Hrs
Thermal shock	-45°C,15min ↔ 85°C,15min 1cycle ,200cycles
High temperature /humidity storage	+85°C, 85% / 500Hrs
Life time	Room Temp. / IF=Typ.mA, 2,000Hrs

Flexible type

- Evaluation criteria : Luminance change within $\pm 10\%$ of initial value

Items	Condition
High temperature/humidity operation	60°C, 90% RH / IF=Typ., 96Hrs
Thermal shock	-30°C,15min ↔ 80°C,15min 1cycle ,50cycles
High temperature /humidity storage	+85°C, 85% / 500Hrs
Life time	Room Temp. / IF=Typ.mA, 2,000Hrs
Bending stress	Bent 1,000 times (from a flat position to a 30mm bending radius)

Reliability

A. Reliability test condition

Operation Lifetime

